

FXM/FXH Series

DIN W72×H72, W48×H96mm Counter/Timer

■ Features

- Counting speed: 1cps/30cps/2kcps/5kcps
 - Selectable voltage input (PNP) method or no-voltage input (NPN) method
 - Input mode: Up, Down, Up/Down
 - Power supply: 100-240VAC 50/60Hz
 - Dot for Decimal Point / Hour. Min. Second by RESET key
 - Selectable Counter/Timer by internal DIP switch
 - [Counter]
20 input modes/18 output modes
 - [Timer]
16 output modes
- Various time setting range - 8-digit model: 0.01 sec to 99999 hour 59.9 min /
6-digit model: 0.1 sec to 99999.9 hour /
4-digit model: 0.01 sec to 9999 hour

- Output: Indicator, 1-stage setting, 2-stage setting

⚠ Please read "Safety considerations" in operation manual before using.



Upgrade

Shaded parts(■) are changed and added functions from previous FX/FXH Series.



■ Ordering Information

FX 4 H - 2P 4

Power supply	4	100-240VAC 50/60Hz
Output	1P	1-stage setting
	2P	2-stage setting
	I	Indicator
Size	H	DIN W48×H96mm
	M	DIN W72×H72mm
Display digit	4	9999 (4-digit)
	6	999999 (6-digit)
	8	99999999 (8-digit)
Item	FX	Counter/Timer

■ Specifications

Model	1-stage setting	FX4H-1P4	FX4M-1P4	FX6M-1P4	FX8M-1P4
	2-stage setting	FX4H-2P4	FX4M-2P4	FX6M-2P4	—
	Indicator	—	FX4M-I4	FX6M-I4	FX8M-I4
Display digit	4-digit				
Character size (W×H)	6×10mm			4×8mm	3.8×7.6mm
Power supply	100-240VAC~ 50/60Hz				
Permissible voltage range	90 to 110% of rated voltage				
Power consumption	● 1-stage: Max. 4.6VA ● 2-stage: Max. 5.8VA ● Indicator: Max. 3.8VA				
Max. counting speed of CP1/CP2	Selectable 1cps/30cps/2kcps/5kcps (DIP switch)				
Return time	Max. 500ms				
Min. signal width	INHIBIT, RESET: approx. 20ms				
Input method	Selectable voltage input (PNP) method or no-voltage input (NPN) method [Voltage input (PNP) method]-input impedance: max. 10.8kΩ, [H]: 5-30VDC ⁻⁻⁻ , [L]: 0-2VDC [No-voltage input (NPN) method]-short-circuit impedance: max. 470Ω, short-circuit residual voltage: max. 1VDC, open-circuit impedance: min. 100kΩ				
One-shot output time	● 1-stage: 0.05 to 5 sec ● 2-stage: 1st setting 0.5 sec fixed, 2nd setting 0.05 to 5 sec				
Control output	Contact	Type	● 1-stage: Instantaneous SPDT (1c) ● 2-stage: OUT1-Instantaneous SPDT (1c), OUT2-Instantaneous SPDT (1c)		
		Capacity	250VAC~ 3A resistive load		
	Solid state	Type	● 1-stage: 1 NPN open collector ● 2-stage: OUT1-1 NPN open collector, OUT2-1 NPN open collector		
		Capacity	● Load voltage: Max. 30VDC ⁻⁻⁻ ● Load current: Max. 100mA ● Residual voltage: Max. 1VDC ⁻⁻⁻		
Relay life cycle	Mechanical	Min. 5,000,000 operations			
	Electrical	Min. 100,000 operations (250VAC 3A resistive load)			
Repeat/Set/Voltage/Temp. error	Max. ±0.01% ±0.05 sec				
Insulation resistance	Over 100MΩ (at 500VDC megger)				
External power supply	Max. 12VDC ⁻⁻⁻ ±10% 50mA				
Memory retention	Approx. 10 years (non-volatile memory)				
Dielectric strength	2,000VAC 50/60Hz for 1 min (between all terminals and case)				
Noise immunity	±2kV the square wave noise (pulse width 1μs) by noise simulator				

Specifications

Model	1-stage setting	FX4H-1P4	FX4M-1P4	FX6M-1P4	FX8M-1P4
	2-stage setting	FX4H-2P4	FX4M-2P4	FX6M-2P4	—
	Indicator	—	FX4M-I4	FX6M-I4	FX8M-I4
Vibration	Mechanical	0.75mm amplitude at frequency 10 to 55Hz (for 1 min) in each X, Y, Z direction for 1 hour			
	Malfunction	0.5mm amplitude at frequency 10 to 55Hz (for 1 min) in each X, Y, Z direction for 10 minutes			
Shock	Mechanical	300m/s ² (approx. 30G) in each X, Y, Z direction for 3 times			
	Malfunction	100m/s ² (approx. 10G) in each X, Y, Z direction for 3 times			
Environment	Ambient temp.	-10 to 55°C, storage: -25 to 65°C			
	Ambient humi.	35 to 85%RH, storage: 35 to 85%RH			
Protection structure		IP20 (front part, IEC standard)			
Approval		CE  us			
Weight ^{*1}	1-stage setting	Approx. 245g (approx. 180g)			
	2-stage setting	Approx. 265g (approx. 200g)			
	Indicator	Approx. 225g (approx. 160g)			

*1: The weight includes packaging. The weight in parenthesis is for unit only.

※Environment resistance is rated at no freezing or condensation.

Connections

FX□M-1P4

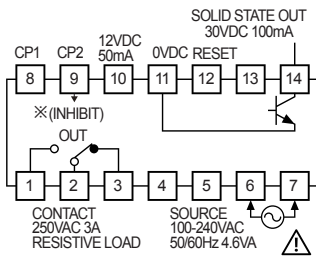

FX□M-2P4

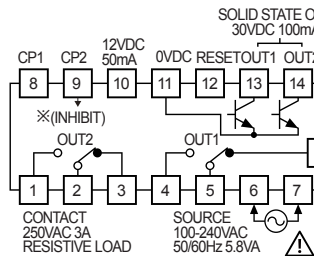

FX□M-I4

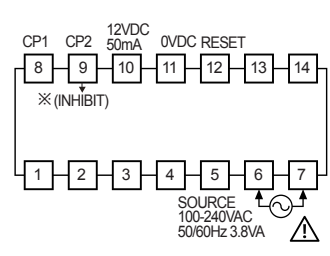

FX4H-1P4

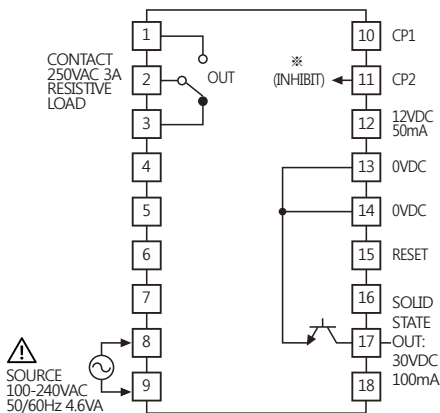

FX4H-2P4

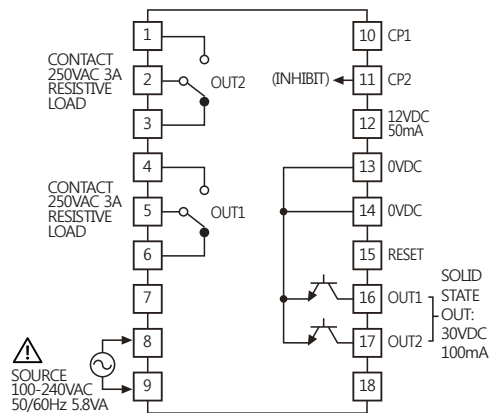

※INHIBIT: In case of timer mode, this terminal is for time hold.

(voltage input (PNP): connect with 12VDC, no-voltage input (NPN): connect with 0VDC)

(A)	Photoelectric Sensors
(B)	Fiber Optic Sensors
(C)	Door/Area Sensors
(D)	Proximity Sensors
(E)	Pressure Sensors
(F)	Rotary Encoders
(G)	Connectors/ Connector Cables/ Sensor Distribution Boxes/Sockets
(H)	Temperature Controllers
(I)	SSRs / Power Controllers
(J)	Counters
(K)	Timers
(L)	Panel Meters
(M)	Tacho / Speed / Pulse Meters
(N)	Display Units
(O)	Sensor Controllers
(P)	Switching Mode Power Supplies
(Q)	Stepper Motors & Drivers & Controllers
(R)	Graphic/ Logic Panels
(S)	Field Network Devices
(T)	Software

FXM/FXH Series

■ Dimensions

※Nameplate design is changed and rear length is shorten than previous.

(unit: mm)

○ FXM Series

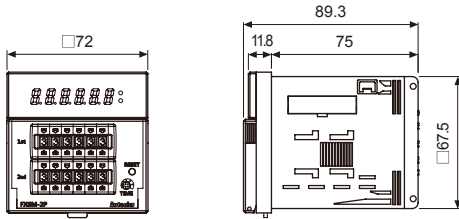

● Bracket

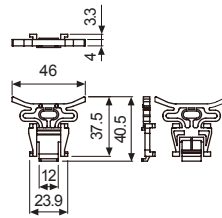

● Panel cut-out

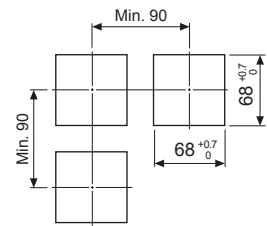

○ FXH Series

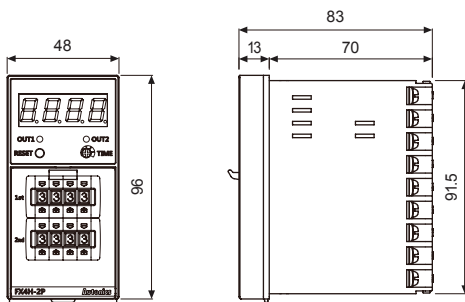

● Bracket

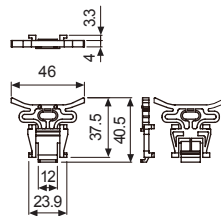

● Panel cut-out

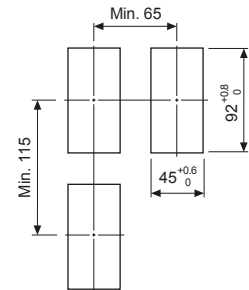

■ Input Connections

○ Voltage input (PNP)

● Solid-state input (standard sensor: PNP output type sensor)

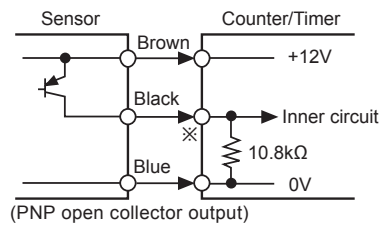
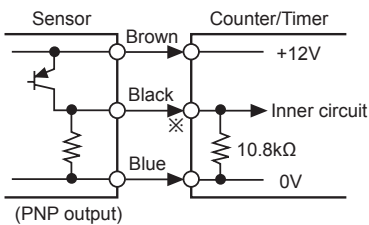

● Contact input

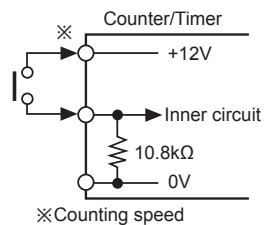

※CP1, CP2 (INHIBIT), RESET input part

※Counting speed
: Set as 1 or 30cps

○ No-voltage input (NPN)

● Solid-state input (standard sensor: NPN output type sensor)

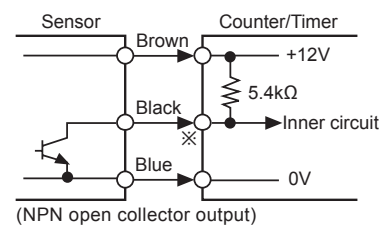
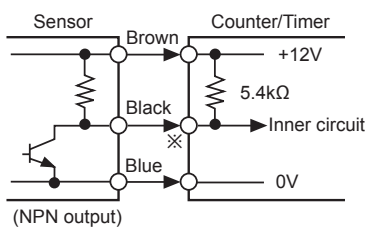

● Contact input

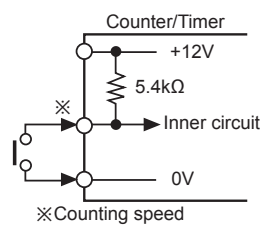

※CP1, CP2 (INHIBIT), RESET input part

※Counting speed
: Set as 1 or 30cps

Up/Down Counter/Timer

Input & Output Connections

When operation load by sensor power

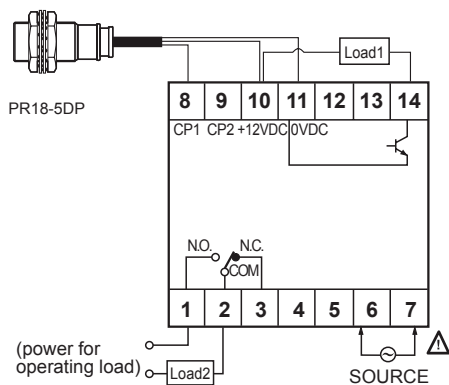

- The sum of operating current capacity of load 1 and sensor should not be over external power capacity (50mA).

When operating load by external power

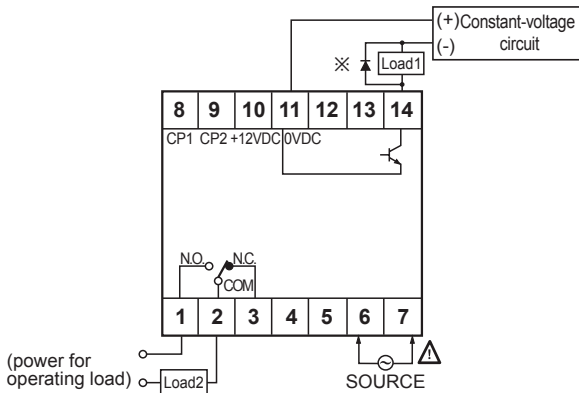

- The capacity of load 1 should not be over transistor switching capacity (max. 30VDC, 100mA)
- Do not supply the reverse polarity power.
 - ⊗ when using inductive load (relay, etc.), connector surge absorber at both ends of the load 1

How to count by external power supply

This unit starts to count when [H] (5-30VDC) is applied at CP1 or CP2 after selecting PNP.

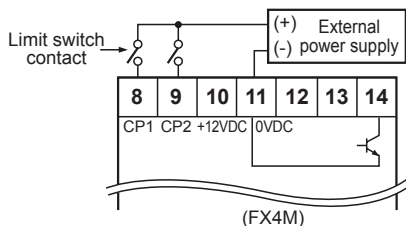

Using 2 counters with one sensor

Please connect as the power of sensor is supplied from only one of counters and design input logic with same way.

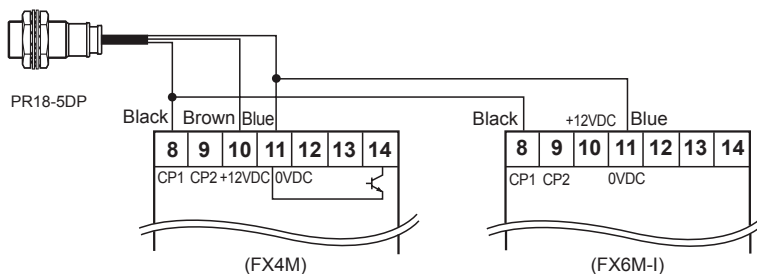

(A) Photoelectric Sensors

(B) Fiber Optic Sensors

(C) Door/Area Sensors

(D) Proximity Sensors

(E) Pressure Sensors

(F) Rotary Encoders

(G) Connectors/ Connector Cables/ Sensor Distribution Boxes/Sockets

(H) Temperature Controllers

(I) SSRs / Power Controllers

(J) Counters

(K) Timers

(L) Panel Meters

(M) Tacho / Speed / Pulse Meters

(N) Display Units

(O) Sensor Controllers

(P) Switching Mode Power Supplies

(Q) Stepper Motors & Drivers & Controllers

(R) Graphic/ Logic Panels

(S) Field Network Devices

(T) Software

FXM/FXH Series

DIP Switch Setting

FXM Series

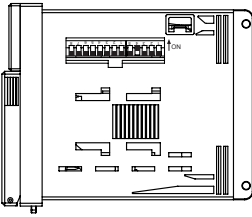

FXH Series

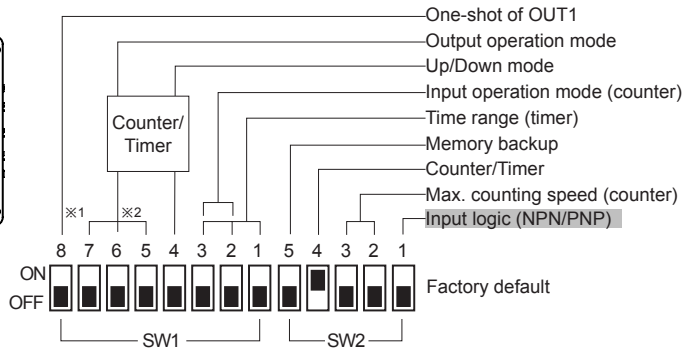
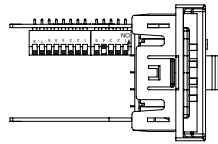

※1: Only 2-stage setting model has no. 8 of SW1.
 ※2: Indicator model does not have no. 5, 6, 7, 8 of SW1.

Input logic

(CP1, CP2, INHIBIT, RESET input)

SW2	Function
ON <input type="checkbox"/>	NPN (no-voltage input)
OFF <input type="checkbox"/>	PNP (voltage input)

Max. counting speed (counter)

SW2	ON	3	2	Function
ON	<input type="checkbox"/>	<input type="checkbox"/>	<input type="checkbox"/>	1cps
OFF	<input type="checkbox"/>	<input type="checkbox"/>	<input type="checkbox"/>	30cps
ON	<input type="checkbox"/>	<input type="checkbox"/>	<input type="checkbox"/>	2kcps
OFF	<input type="checkbox"/>	<input type="checkbox"/>	<input type="checkbox"/>	5kcps

Counter/Timer

SW2	Function
ON <input type="checkbox"/>	Counter mode
OFF <input type="checkbox"/>	Timer mode

Memory backup

SW2	Function
ON <input type="checkbox"/>	No memory backup
OFF <input type="checkbox"/>	Memory backup

Up/Down mode

SW1	Function
ON <input type="checkbox"/>	Down mode
OFF <input type="checkbox"/>	Up mode

Time range (timer)

SW1	4-digit	6-digit	8-digit
ON <input type="checkbox"/>	99.99sec	99999.9sec	999999.99sec
OFF <input type="checkbox"/>	999.9sec	999999sec	9999999.9sec
ON <input type="checkbox"/>	9999sec	99min 59.99sec	99999999sec
OFF <input type="checkbox"/>	99min 59sec	999min 59.9sec	99999min 59.9sec
ON <input type="checkbox"/>	999.9min	99999.9min	9999999.9min
OFF <input type="checkbox"/>	99hour 59min	99hour 59min 59.9sec	999hour 59min 59.9sec
ON <input type="checkbox"/>	999.9hour	9999hour 59min	9999hour 59min 59sec
OFF <input type="checkbox"/>	9999hour	99999.9hour	99999hour 59.9min

One-shot output of OUT1

SW1	Function
ON <input type="checkbox"/>	One-shot output of OUT1
OFF <input type="checkbox"/>	Self-holding output of OUT1

※This function is for setting one-shot output (0.5 sec fixed) or self-holding output (until OUT2 turns OFF) of OUT1 at 2-stage setting model.

※Example of output operation mode F

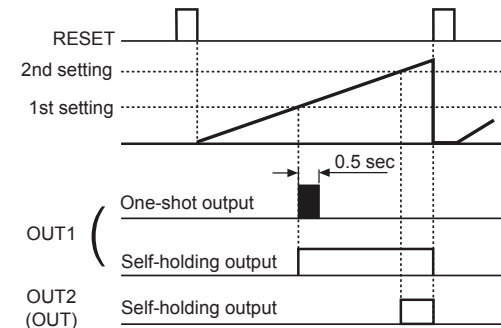

Up/Down Counter/Timer

Input Operation Mode (Counter)

※CP: Clock Pulse

Input mode		SW1	Voltage input (PNP) method	No-voltage input (NPN) method	
Up mode	Up/Down-A (command input)	ON			
		OFF			
		ON			
	Up/Down-B (individual input)	OFF			
		ON			
		OFF			
Up (adding input)	ON				
	OFF				
Down mode	Up/Down-D (command input)	ON			
		OFF			
		ON			
	Up/Down-E (individual input)	OFF			
		ON			
		OFF			
Down (subtracting input)	ON				
	OFF				

※A: over min. signal width, B: over than 1/2 of min. signal width. If the signal is smaller than these width, it may cause counting error (±1).

- (A) Photoelectric Sensors
- (B) Fiber Optic Sensors
- (C) Door/Area Sensors
- (D) Proximity Sensors
- (E) Pressure Sensors
- (F) Rotary Encoders
- (G) Connectors/ Connector Cables/ Sensor Distribution Boxes/Sockets
- (H) Temperature Controllers
- (I) SSRs / Power Controllers
- (J) Counters
- (K) Timers
- (L) Panel Meters
- (M) Tacho / Speed / Pulse Meters
- (N) Display Units
- (O) Sensor Controllers
- (P) Switching Mode Power Supplies
- (Q) Stepper Motors & Drivers & Controllers
- (R) Graphic/ Logic Panels
- (S) Field Network Devices
- (T) Software

FXM/FXH Series

Output Operation Mode

		 One-shot output of OUT2 (0.05 to 5 sec)	 Self-holding output	 One-shot output of OUT1 (0.5 sec fixed)	 Self-holding output	
Output mode (SW1)	ON OFF Up mode			ON OFF Down mode	Operation	
	Up, Up/Down-A, B, C			Down, Up/Down-D, E, F		
F	 RESET 2nd setting 1st setting 0 OUT1 OUT2 (OUT)			 RESET 2nd setting 1st setting 0 OUT1 OUT2 (OUT)	After count-up, counting display value increases or decreases until reset signal input is applied and self-holding output is maintained.	
N	 RESET 2nd setting 1st setting 0 OUT1 OUT2 (OUT)			 RESET 2nd setting 1st setting 0 OUT1 OUT2 (OUT)	After count-up, counting display value and self-holding output are maintained until reset signal input is applied.	
C	 RESET 2nd setting 1st setting 0 OUT1 OUT2 (OUT)			 RESET 2nd setting 1st setting 0 OUT1 OUT2 (OUT)	When count-up, counting display value is reset and it counts simultaneously. Self-holding output of OUT1 turns OFF after one-shot output time of OUT2. One-shot output time of OUT1 is regardless of OUT2 output.	
R	 RESET 2nd setting 1st setting 0 OUT1 OUT2 (OUT)			 RESET 2nd setting 1st setting 0 OUT1 OUT2 (OUT)	After count-up, counting display value is reset after one-shot output time of OUT2 and it counts simultaneously. Self-holding output of OUT1 turns OFF after one-shot output time of OUT2. One-shot output time of OUT1 is regardless of OUT2 output.	
K	 RESET 2nd setting 1st setting 0 OUT1 OUT2 (OUT)			 RESET 2nd setting 1st setting 0 OUT1 OUT2 (OUT)	After count-up, counting display value increases or decreases until reset signal input is applied. Self-holding output of OUT1 turns OFF after one-shot output time of OUT2. One-shot output time of OUT1 is regardless of OUT2 output.	
P	 RESET 2nd setting 1st setting 0 OUT1 OUT2 (OUT)			 RESET 2nd setting 1st setting 0 OUT1 OUT2 (OUT)	After count-up, counting display value is maintained while OUT2 output is ON. Counting value is internally reset and it counts simultaneously. When OUT2 output is OFF, displays counting value while OUT2 output is ON, and it increases or decreases. Self-holding output of OUT1 turns OFF after one-shot output time of OUT2.	
Q	 RESET 2nd setting 1st setting 0 OUT1 OUT2 (OUT)			 RESET 2nd setting 1st setting 0 OUT1 OUT2 (OUT)	After count-up, counting display value increases or decreases during one-shot time of OUT2. Self-holding output of OUT1 turns OFF after one-shot output time of OUT2. One-shot output time of OUT1 is regardless of OUT2 output.	
S	Up			Down	<ul style="list-style-type: none"> Up, Up/Down-A, B, C input mode : OUT1 output maintains ON when counting display value is larger or equal than 1st setting value. OUT2 output maintains ON when counting display value is larger or equal than 2nd setting value. Down, Up/Down-D, E, F input mode : OUT1 output maintains ON when counting display value is smaller or equal than 1st setting value. OUT2 output maintains ON when counting display value is smaller or equal than 2nd setting value. 	
	Counter mode	 RESET 2nd setting 1st setting 0 OUT1 OUT2 (OUT)	Up/Down-A, B, C	 RESET 2nd setting 1st setting 0 OUT1 OUT2 (OUT)		Up/Down-D, E, F
S	Timer mode	 RESET 2nd setting 1st setting 0 OUT1 OUT2 (OUT)			 RESET 2nd setting 1st setting 0 OUT1 OUT2 (OUT)	OUT1 and OUT2 turns OFF→ON→OFF repeatedly (flicker).

※Set one-shot output time by front TIME volume switch.

Up/Down Counter/Timer

■ Counting & Time Operation For Indicator (FX□M-I4)

○ Counting operation

● Input mode: Up

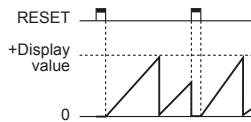

● Input mode: Down

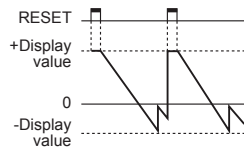

● Input mode: Up / Down-A, B, C

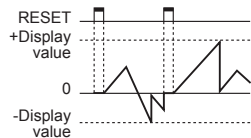

● Input mode: Up / Down-D, E, F

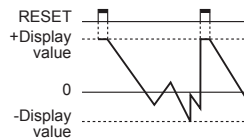

○ Time operation

● Up mode

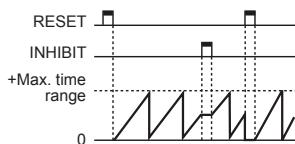

● Down mode

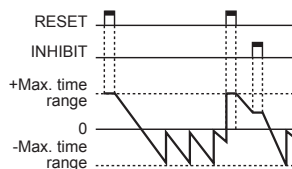

■ Dot For Decimal Point / Hour. Min. Second

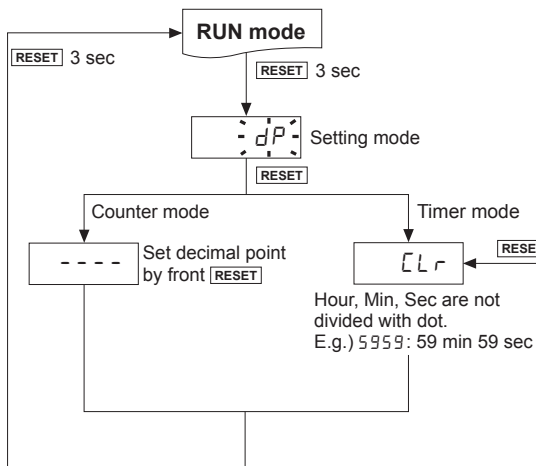

※In run mode, hold the **[RESET]** key for over 3 sec, and it enters setting mode [dP].

※In setting mode, hold the **[RESET]** key for over 3 sec, and it saves the setting and returns to RUN mode.

※If there is no **[RESET]** key input for 60 sec when entering setting mode, it returns to RUN mode.

Hour, Min, Sec are not divided with dot.
E.g.) 5959 : 59 min 59 sec

Hour, Min, Sec are divided with dot.
E.g.) 059.59 : 59 min 59 sec

(A) Photoelectric Sensors

(B) Fiber Optic Sensors

(C) Door/Area Sensors

(D) Proximity Sensors

(E) Pressure Sensors

(F) Rotary Encoders

(G) Connectors/ Connector Cables/ Sensor Distribution Boxes/Sockets

(H) Temperature Controllers

(I) SSRs / Power Controllers

(J) Counters

(K) Timers

(L) Panel Meters

(M) Tacho / Speed / Pulse Meters

(N) Display Units

(O) Sensor Controllers

(P) Switching Mode Power Supplies

(Q) Stepper Motors & Drivers & Controllers

(R) Graphic/ Logic Panels

(S) Field Network Devices

(T) Software

■ Proper Usage

◎ Reset

● Reset

In case of changing the input mode after supplying the power, please provide an external reset or manual reset. **If reset is not executed, the counter will be working in previous mode.**

● Reset signal width

It is reset perfectly when the reset signal is applied during **min. 20ms** regardless of the contact input & solid-state input.

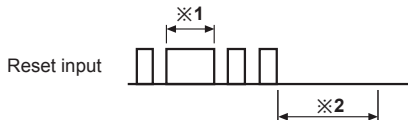

※1: In case of a contact reset, contact chattering will not affect the reset as long as it is applied for a minimum of 20ms.

※2: Input signal at CP1 & CP2 must be applied for a minimum of 50ms after the reset is removed.

◎ Min. count signal width

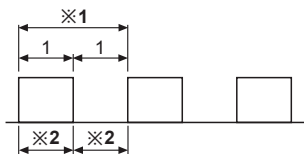

※1: Please make duty ratio (ON/OFF) as 1:1.

※2: Min. signal width

1cps: Min. 500ms
30cps: Min. 16.7ms
2kcps: Min. 0.25ms
5kcps: Min. 0.1ms

◎ Max. counting speed

This is a response speed per 1 sec when the duty ratio (ON:OFF) of input signal is 1:1. If the duty ratio is not 1:1, the width between ON and OFF should be over min. signal width and the response speed will get slower against input signal. If either ON or OFF signal is shorter than min. signal width, this product may not respond.

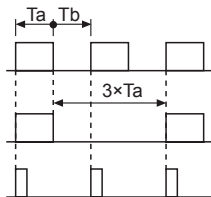

Ta (ON width) and Tb (OFF width) needed to be over min. signal width.

Max. counting speed is 1/2 value of rated spec. when duty ratio is 1:3.

It can not respond if it is smaller than min. signal width (Ta).

◎ Error

Display	Error	Troubleshooting
Err0	Setting value is 0.	Change the setting value anything but 0.

※If error occurs, the output turns OFF.

※In case of 2-stage setting model, error displays when 2nd setting value is 0 (zero).

※1st setting value is set as 0 (zero), OUT1 maintains OFF. 2nd setting value is smaller than 1st setting value, 1st setting value is ignored and only OUT2 output operates.

※Indicator model does not have error display function.

◎ INHIBIT (for timer)

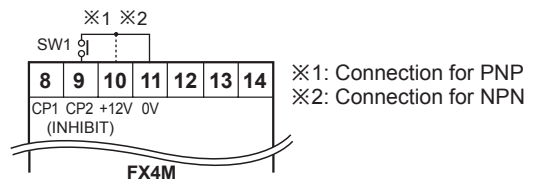

- INHIBIT mode is active when SW1 turns ON. (Time Hold)
- When power is applied, it starts to progress and INHIBIT mode is used to stop the time is under the progress at the moment.
- When SW1 is OFF, timer starts to progress again.

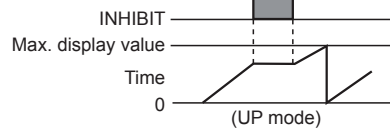

◎ Power

- The inner circuit voltage rises within 100ms after supplying the power to the unit. The input may be unavailable at this period. Be sure that the inner circuit voltage drops within 500ms after turning OFF the power.

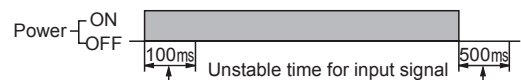

- Use the unit within the rated power supply. When supplying or cutting the power, use a switch not to occur chattering.



◎ Detaching Case or DIP Switch Cover

※Turn OFF the power before detaching the case or DIP switch cover.

● FXM Series

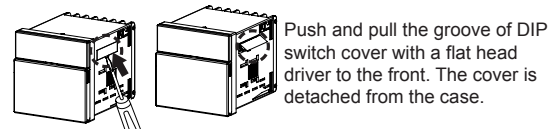

● FXH Series

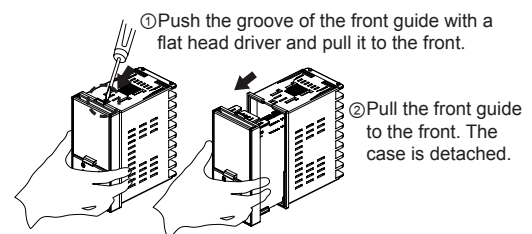

⚠ Be sure not to be wounded when using a tool.