

# Autonics

## Door Side Sensor ADS-SE

### INSTRUCTION MANUAL



Thank you for choosing our Autonics product.  
Please read the following safety considerations before use.

#### ■ Safety Considerations

- ※Please observe all safety considerations for safe and proper product operation to avoid hazards.
- ※Safety considerations are categorized as follows.
- ⚠Warning Failure to follow these instructions may result in serious injury or death.
- ⚠Caution Failure to follow these instructions may result in personal injury or product damage.
- ※The symbols used on the product and instruction manual represent the following
- ⚠ symbol represents caution due to special circumstances in which hazards may occur.

#### ⚠ Warning

- Fail-safe device must be installed when using the unit with machinery that may cause serious injury or substantial economic loss. (e.g. nuclear power control, medical equipment, ships, vehicles, railways, aircraft, combustion apparatus, safety equipment, crime/disaster prevention devices, etc.) Failure to follow this instruction may result in fire, personal injury, or economic loss.
- Use this product as secondary safety aid for door sensor. Failure to follow this instruction may result in personal injury or economic loss.
- Since the purpose of this product is secondary safety aid, please use it with another door sensor.
  - ①Although install this product near the sensing area, object in the nearest area from the door can not be detected. It is hard to detect kids or elders consecutively, they can be caught by the auto door.
  - ②Keep opened as much as setting time. Since door closes after the setting time, people can be caught by the auto door.
- Do not connect, repair, or inspect the unit while connected to a power source. Failure to follow this instruction may result in fire.
- Check 'Connections' before wiring. Failure to follow this instruction may result in fire.
- Do not disassemble or modify the unit. Failure to follow this instruction may result in fire.

#### ⚠ Caution

- Use the unit within the rated specifications. Failure to follow this instruction may result in fire or product damage.
- Use dry cloth to clean the unit, and do not use water or organic solvent. Failure to follow this instruction may result in fire.
- Do not use the unit in the place where flammable/explosive/corrosive gas, humidity, direct sunlight, radiant heat, vibration, impact, or salinity may be present. Failure to follow this instruction may result in fire or explosion.
- Do not use a load over the range of rated relay specification. Failure to follow this instruction may result in insulation failure, contact melt, contact failure, relay broken, or fire.

#### ■ Identification

##### <Controller part>

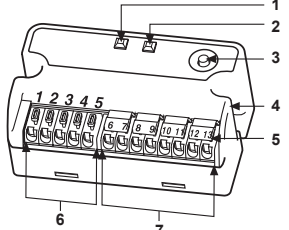

- Display LED (Red)
- Display LED (Green)
- Sensitivity setting button
- Mounting hole
- Wiring connection button
- Terminal for power and output (No. 1 to 5)
- Terminal for the sensor (No. 6 to 13)

##### <Sensor part>

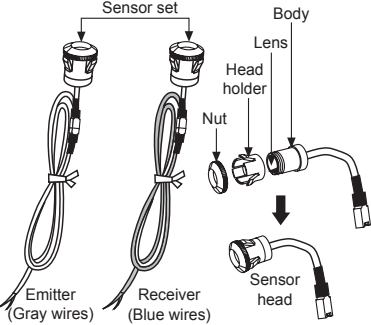

※It is able to use 2sets of the sensor with this product. If necessary, purchase a set more.

#### ■ Specifications

Model	ADS-SE
Sensor wire length	10m
Detecting type	Through-beam type
Detecting distance	0 to 10m
Sensing target	Opaque materials of Min. Ø15mm
Power supply	12-24VAC~, 12-24VDC±10% 50/60Hz(Ripple P-P: max. 10%)
Power consumption/Current	AC: max. 2VA / DC: max. 50mA
Contact output	Contact capacity: 50VDC= 0.3A(Resistive load) Contact composition: 1C Relay life cycle: Mechanical Min. 5,000,000 times, Electrical Min. 100,000 times
Response time	Approx. 50ms(From a beam cut off)
Output holding time	Approx. 500ms(From a beam received)
Available sensor set	2set
Indication	Operating indicator (See "How to use" for the display status in operation)
Light source	Infrared diode(850nm modulated)
Ambient illumination	Sunlight: max. 100,000lx (Illumination of received light side)
Ambient temperature	-20 to 55°C. Storage: -25 to 60°C
Ambient humidity	35 to 85%RH, Storage: 35 to 85%RH
Protection	IP30(IEC standards)
Material	Case: ABS, Lens: PMMA
Accessories	Sensor 1set(ADS-SH), Fixed bolt 2 piece
Unit weight	Approx. 300g

※Environment resistance is rated at no freezing or condensation.

#### ■ Dimensions

(Unit:mm)

##### ○ Controller(ADS-SEC)

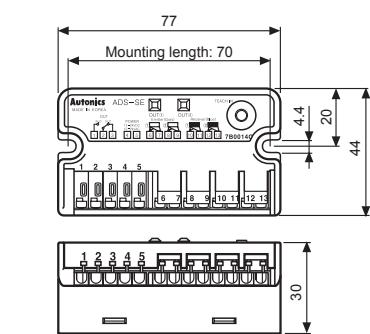

##### ○ Sensor(ADS-SH)

<One push type>

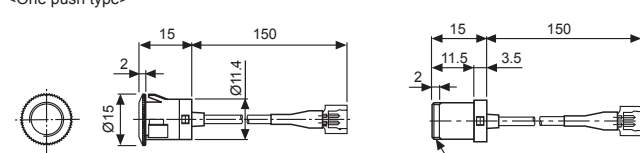

※It is able to purchase a controller(ADS-SEC)and sensor cable(ADS-SH:10m) separately.

##### ○ Bracket: ADS-SB12, ADS-SB10

- For mounting by one push(ADS-SB12)
- For mounting by screw(ADS-SB10)

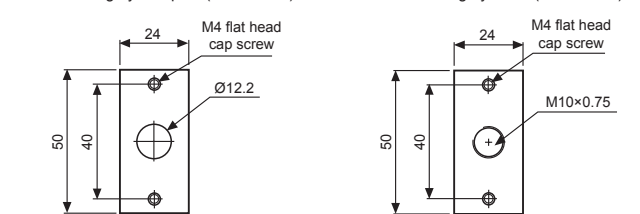

※The mounting bracket(ADS-SB12, ADS-SB10) of sensor is sold separately.

#### ■ Installation

##### ■ Controller installation

- Please fix controller with the bolts(M4×20, 2 piece). Please process the fixing hole of controller by M4. Please see dimension for installation.

##### 1. Please follow as below when adjusting wiring length.

- ①Please cut off the wiring length as much as user needs.
- ②Please connect the wire to the terminal after taking off the wire covering. It will be easy to connect if soldering the end of the wires.

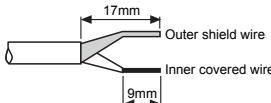

##### 2. Please match wires in the number of terminals and connect them.

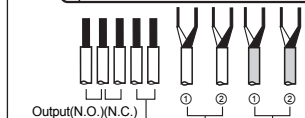
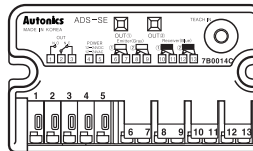

- ▶ Connection method for sensor
- Please put outer shield and inner covered wires at once, pressing the inserting button, then take off from the button.

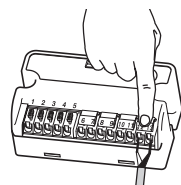

- ▶ Connection method for power and output wires.
- Please put the wires pressing the terminal by a driver etc.

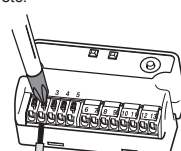

- Allowable diameter of power and output wires.
- Single wire:Ø0.12 to 1.6mm<sup>2</sup>(AWG26 to 16)
- Stranded wire:Ø0.13 to 1.5mm<sup>2</sup>(AWG26 to 16)

※The above specifications are subject to change and some models may be discontinued without notice.

##### ⚠ Warning When fixing controller

- Please do not screw the bolts too tightly. The fixing hole of controller may be broken.

##### ⚠ Warning It may give an electric shock.

- Please be sure of connecting wires in power off.

##### ⚠ Caution It may cause damage to this product.

- Please follow the left picture when cutting off the wires of sensor head. If the wire covering is taken off too much it may cause damage to this product as the end of both wires is shorted.

##### ⚠ Caution Do not extend the wire of sensor head.

- Please don't connect extended wire to the wire of sensor head. It may cause malfunction by noise.

##### ⚠ Caution It may cause damage to this product.

- Please don't connect two wires or more to a terminal.

##### ⚠ Caution Wiring connection

- It doesn't operate normally if the wiring is connected conversely.

##### ⚠ Caution It may cause damage to this product.

- Please make sure of connecting power wire to the terminal(No. 4, 5). Otherwise, it may cause damage to this product.

#### ■ Caution for sensor installation

- Sensing distance is 10m. Please install it in the rated distance.
- Please install the sensor with more than 50cm gap from the bottom and ceiling. It may cause malfunction by reflected beams from the surface of the bottom and ceiling.
- Please do not put obstacles between emitter and receiver. It may cause malfunction.
- When using door sensors closely over two units, it may result in malfunction due to mutual interference. Do not exchange the position of the head of emitter and receiver. Keep the distance between the heads more than 50cm. This product is for indoor.
- Please avoid the place where exposed in direct sunlight or is in over rated intensity of illumination.

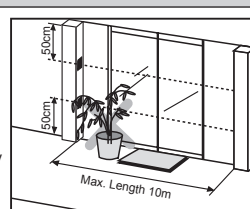

##### 1. Please make a hole on the side post of auto door as follows.

- ▶ When not using the mounting bracket
- Mounting hole of sensor head: Ø12.2±0.1mm
- Panel thickness of sensor head: 1.5±0.5 mm
- ▶ When using the mounting bracket
- Through hole of sensor head: Ø13 to Ø14mm
- Screw hole for fixing the bracket : M4 TAP or Ø3.5

##### 2. Please mount the sensor head in the mounting hole

- ▶ When not using the mounting bracket
- One push method
- Please insert the sensor head into the mounting hole like the right picture.
- ▶ When using the mounting bracket
- One push method
- ①Please install the sensor head at the bracket first.
- ②Please fix the bracket by screws on the place for installing.

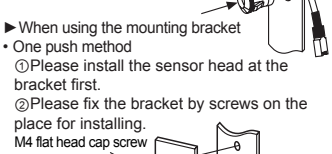

- Screw method
- ①Please remove nuts and the head holder from the sensor head.
- ②Please install the sensor head on the bracket.
- ③Please fix the bracket on the side post of the door by screws.

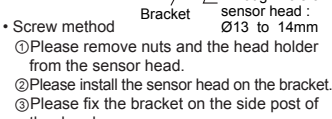

- Please keep the sensor head clean. It may not operate normally. Please clean it by a piece of close with a neutral detergent.
- Do not use water or an oil-based detergent when you clean the head part of sensor. It may cause a product damage.

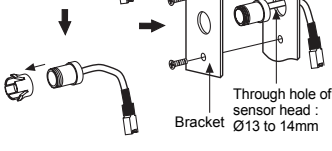

※Be sure to follow cautions written in the instruction manual and the technical descriptions (catalog, homepage).

#### ■ How to Use

##### ■ Sensitivity setting

Set sensitivity after mount this product for a normal operation. It sets the optimum sensitivity automatically at the controller according to installed environment.

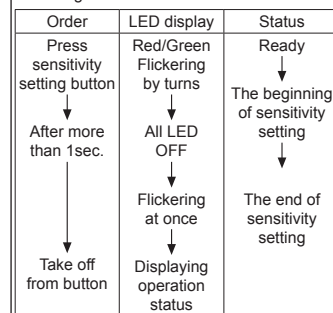

##### ⚠ Caution Before sensitivity setting

- Please check the wiring again with the connection diagram.
- When setting sensitivity, the through beam must not be shaken and cut off.
- Please do not put obstacles like a pot on the passage of the through beam.
- It may cause malfunction in above cases from lack of sensitivity or abnormal sensitivity setting.

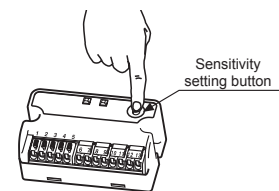

##### Please check LED display after setting the sensitivity.

- When sensitivity setting button is pressed less than 1sec sensitivity setting is cancelled, then it operates by previous setting.

##### ■ Sensitivity status and check after setting sensitivity

☼: light ON, Ⓛ: flash, ●: light OFF

Connecting sensor	LED display		Status	
	Red	Green	After setting sensitivity	In operation
1set	☼	●	Sensitivity setting success	Beam received
	Ⓛ	●	Sensitivity setting failure	Emitter disconnected or added
	●	●	—	Lack of sensitivity
	●	●	—	Beam cut off
2set	☼	☼	1, 2Channel sensitivity setting success	1, 2Channel beam received
	☼	Ⓛ	1Channel success, 2Channel failure	Lack of 2channel sensitivity
	☼	●	—	1Channel beam received, 2Channel beam cut off
	Ⓛ	☼	1Channel failures, 2Channel success	1Channel beam cut off, 2Channel beam received
	●	●	—	1 Lack of channel sensitivity
	●	●	—	1, 2Channel sensitivity setting failure

- ※After completing sensitivity setting in using an through beam red LED is flickering, green LED is off. Only red LED displays the operation status.
- ※After completing sensitivity setting in using two through beams red LED indicates the operation status of receiver set by receiver ① and green LED indicates the operation status of receiver set by receiver ②.
- ※Self diagnostic function
- If lack of sensitivity occurs by optical axes not matched and pollution by dust on the lens of Emitter/Receiver etc. in operation the LED of normal operation channel will be flash due to unstable operation.

- Check process for sensitivity setting failure
- ①Please check obstacles between the heads of Emitter/Receiver.
- ②Please check pollutant on the lens of Emitter/Receiver.
- ③Please check wires cut off and the connection with the connection diagram on the controller.
- ④Please check if the head of Emitter /Receiver is inclined or not.
- ⑤Please set sensitivity again after removing above problem.
- ※When sensitivity setting is failure even though above problem is solved please contact us.

#### ■ Operation check

Please check the operation flow chart below.

☼: light ON, ●: light OFF

Operation	Power OFF	Normal operation No human or any material is passing between sensors(When through beam cut off)	Human or material is passing between sensors(When through beam cut off)	After human or material passed
LED display	LED OFF	☼ (red/green)	●	☼ (red/green)
Relay output	N.O.	OPEN	CLOSE	OPEN
	N.C.	CLOSE	OPEN	CLOSE

#### ■ Troubleshooting

Malfunction	Caution	Troubleshooting
It is not work.	<ul style="list-style-type: none"> <li>• Power voltage</li> <li>• Cable cut, disconnection</li> <li>• Rated detecting distance</li> </ul>	<ul style="list-style-type: none"> <li>• Check the power cable and adjust power voltage.</li> <li>• Please check wiring and terminal.</li> <li>• Use it in rated detecting distance.</li> </ul>
Sometimes it is not work.	<ul style="list-style-type: none"> <li>• Pollution by pollutant on the lens of Emitter/Receiver.</li> </ul>	<ul style="list-style-type: none"> <li>• Remove the pollutant.</li> </ul>
It is operated even if people does not enter in detection area.	<ul style="list-style-type: none"> <li>• Rated detecting distance</li> <li>• There are obstacles between Emitter and Receiver.</li> <li>• There are equipments generating strong noise or ratio wave(Motor, Generator, High-tension wire).</li> </ul>	<ul style="list-style-type: none"> <li>• Use it in rated detecting distance.</li> <li>• Remove obstacles.</li> <li>• Keep away from the equipment generating strong noise or ratio wave.</li> </ul>

#### ■ Cautions during Use

- Follow instructions in 'Cautions during Use'. Otherwise, It may cause unexpected accidents.
- 12-24VDC, 12-24VAC power supply should be insulated and limited voltage/current or Class 2, SELV power supply device.
- Use the product, 1 sec after supplying power. When using separate power supply for the sensor and load, supply power to sensor first.
- When using switching mode power supply to supply the power, ground F.G. terminal and connect a condenser between 0V and F.G. terminal to remove noise.
- When connecting a DC relay or other inductive load, remove surge by using diodes or varistors.
- Wire as short as possible and keep away from high voltage lines or power lines, to prevent surge and inductive noise.
- This unit may be used in the following environments.
  - ①Indoors (in the environment condition rated in 'Specifications')
  - ②Altitude max. 2,000m
  - ③Pollution degree 3
  - ④Installation category II

#### ■ Major Products

- Photoelectric Sensors
- Fiber Optic Sensors
- Door Sensors
- Door Side Sensors
- Area Sensors
- Proximity Sensors
- Pressure Sensors
- Rotary Encoders
- Connector/Sockets
- Switching Mode Power Supplies
- Control Switches/Lamps/Buzzers
- I/O Terminal Blocks & Cables
- Stepper Motors/Drivers/Motion Controllers
- Graphic/Logic Panels
- Field Network Devices
- Laser Marking System (Fiber, Co., Nd: YAG)
- Laser Welding/Cutting System
- Temperature Controllers
- Temperature/Humidity Transducers
- SSRs/Power Controllers
- Counters
- Timers
- Panel Meters
- Tachometer/Pulse (Rate) Meters
- Display Units
- Sensor Controllers

**Autonics Corporation**  
http://www.autonics.com

■ HEADQUARTERS:  
18, Bansong-ro 513beon-gil, Haeundae-gu, Busan, South Korea, 48002  
TEL: 82-51-519-3232  
■ E-mail: sales@autonics.com